



**LED Display**  
**Product Data Sheet**  
LTS-4801JG

Spec No. :DS30-2001-366  
Effective Date: 10/16/2024  
Revision: A

**LITE-ON DCC**

**RELEASE**

**BNS-OD-FC001/A4**

**LED DISPLAY  
LTS-4801JG**

**LED DISPLAY**

LTS-4801JG

<u>Rev</u>	<u>Description</u>	<u>By</u>	<u>Date</u> (DD/MM/YY)
01	Preliminary Spec	Meg Huang	19-Oct-2001
<b>Above data for PD and Customer tracking only</b>			
-	NPPR Received and Upload on system	Meg Huang	19-Oct-2001
A	Add CAUTIONS	Anon B.	21-Jun-2024

## LED DISPLAY LTS-4801JG

### 1. Description

The LTS-4801JG is a 0.4-inch (10.0-mm) height single digit seven-segment display. This device utilizes AllnGaP Green LED chips, which are made from AllnGaP on a non-transparent GaAs substrate, and has a gray face and white segments

#### 1.1 Features

- 0.40 inch (10 mm) DIGIT HEIGHT
- CONTINUOUS UNIFORM SEGMENTS
- LOW POWER REQUIREMENT
- EXCELLENT CHARACTERS APPEARANCE
- HIGH BRIGHTNESS & HIGH CONTRAST
- WIDE VIEWING ANGLE
- SOLID STATE RELIABILITY
- CATEGORIZED FOR LUMINOUS INTENSITY
- **LEAD-FREE PACKAGE (ACCORDING TO ROHS)**

#### 1.2 Device

Part No	Description
AllnGaP Green	Common Anode
LTS-4801JG	Rt. Hand Decimal

**LED DISPLAY  
LTS-4801JG**

**2. Package Dimensions**

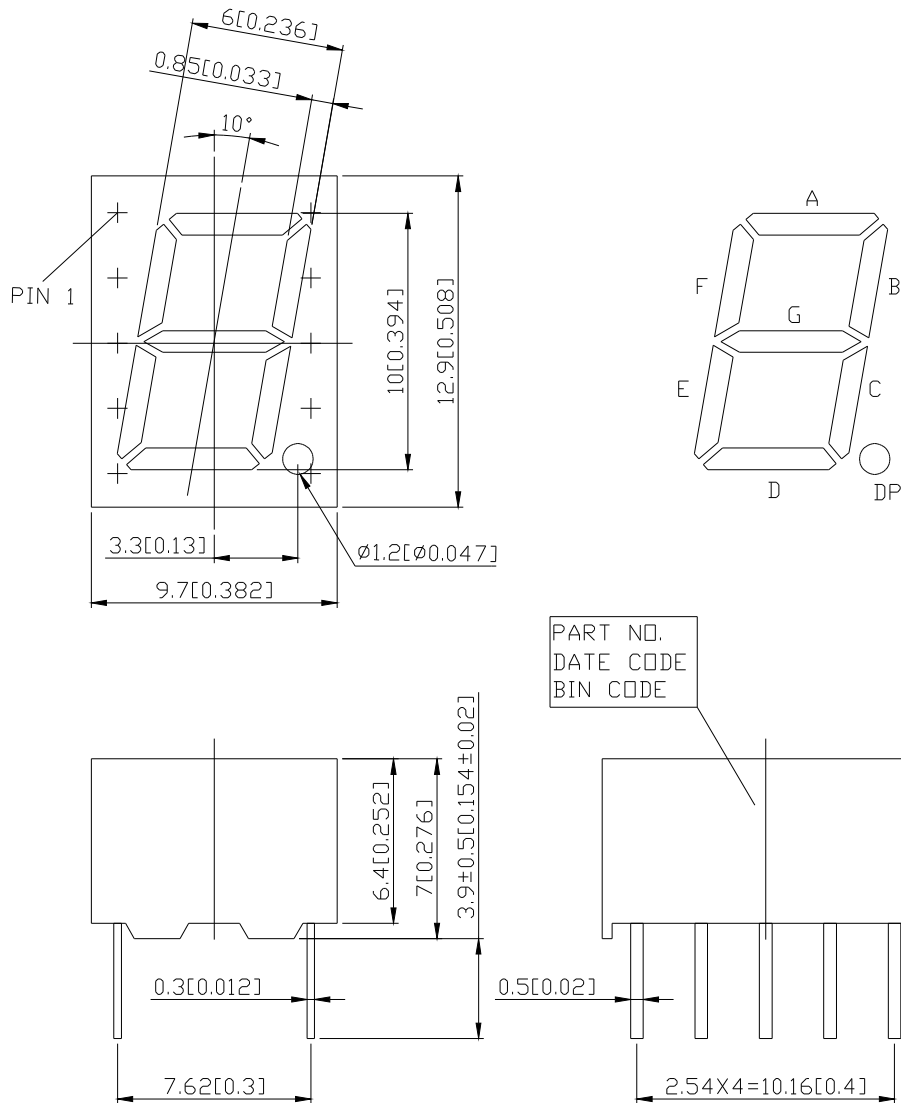

**Notes :**

1. All dimensions are in millimeters. Tolerances are  $\pm 0.25\text{mm}$  (0.01") unless otherwise noted.
2. Foreign materials on segment  $\leq 10\text{mils}$ .
3. Bubble in segment  $\leq 10\text{mils}$ .
4. Bending  $\leq 1\%$  of reflector length.
5. Ink contamination (surface)  $\leq 20\text{mils}$ .
6. Pin tip's shift tolerance is  $\pm 0.40\text{ mm}$ .
7. Recommend the best pcb hole : diameter 1.10 mm

**LED DISPLAY  
LTS-4801JG**

**3. Internal Circuit Diagram**

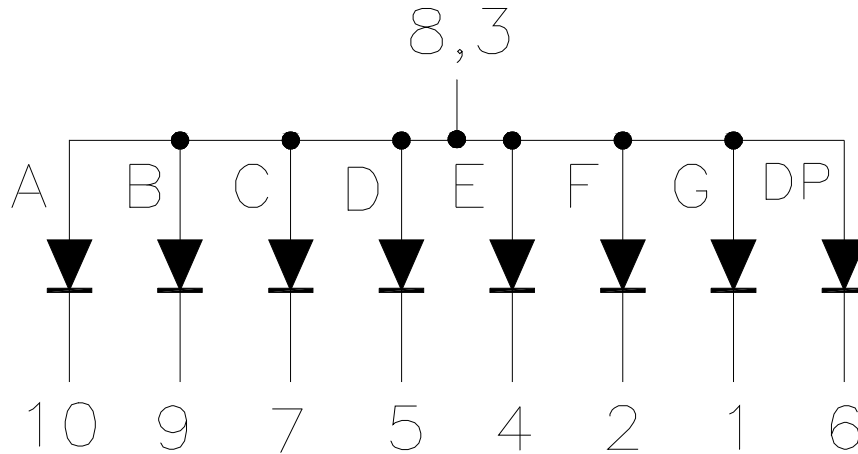

**4. Pin Connection**

No.	CONNECTION
1	CATHODE G
2	CATHODE F
3	COMMON ANODE
4	CATHODE E
5	CATHODE D
6	CATHODE D.P.
7	CATHODE C
8	COMMON ANODE
9	CATHODE B
10	CATHODE A

## LED DISPLAY LTS-4801JG

### 5. Rating and Characteristics

#### 5.1. Absolute Maximum Rating at Ta=25°C

Parameter	Maximum Rating	Unit
Power Dissipation Per Segment	70	mW
Peak Forward Current Per Segment ( 1/10 Duty Cycle, 0.1ms Pulse Width )	60	mA
Continuous Forward Current Per Segment	25	mA
Derating Linear From 25°C Per Segment	0.33	mA/°C
Operating Temperature Range	-35°C to +85°C	
Storage Temperature Range	-35°C to +85°C	
Solder Conditions: 1/16 inch below seating plane within 5 seconds at max 260°C or temperature of unit (during assembly) not over max. temperature rating above.		

#### 5.2. Electrical / Optical Characteristics at Ta=25°C

Parameter	Symbol	MIN.	TYP.	MAX.	Unit	Test Condition
Average Luminous Intensity	IV	320	850		ucd	IF=1mA
Peak Emission Wavelength	$\lambda_p$		571		nm	IF=20mA
Spectral Line Half-Width	$\Delta\lambda$		15		nm	IF=20mA
Dominant Wavelength	$\lambda_d$		572		nm	IF=20mA
Forward Voltage Per Chip	VF		2.05	2.6	V	IF=20mA
Reverse Current Per Segment <sup>(*)</sup>	IR			100	$\mu$ A	VR=5V
Luminous Intensity Matching Ratio (Similar Light Area)	IV-m			2:1		IF=1mA

#### Notes :

- Luminous intensity is measured with a light sensor and filter combination that approximates the CIE (Commission International De L'Eclairage) eye-response curve.
- Reverse voltage is only for IR test. It cannot continue to operate at this situation.
- Cross talk specification  $\leq$  2.5%.

**6. Typical Electrical / Optical Characteristics Curves**

( 25°C Ambient Temperature Unless Otherwise Noted )

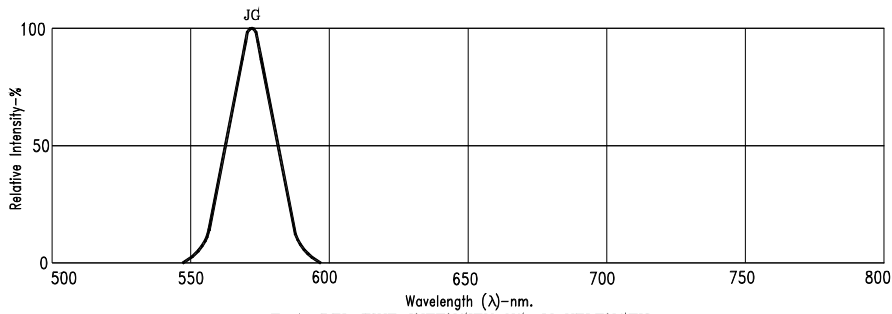

Fig1. RELATIVE INTENSITY VS. WAVELENGTH

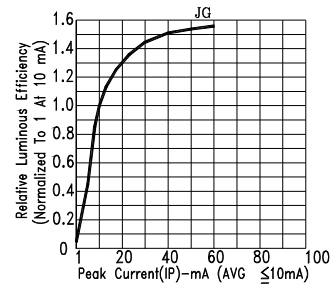

Fig2. RELATIVE LUMINOUS EFFICIENCY (LUMINOUS INTENSITY PER UNIT CURRENT) VS. PEAK CURRENT

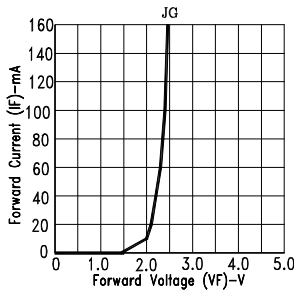

Fig3. FORWARD CURRENT VS. FORWARD VOLTAGE

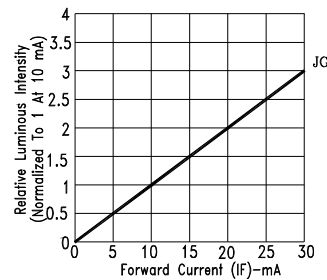

Fig4. RELATIVE LUMINOUS INTENSITY VS. FORWARD CURRENT

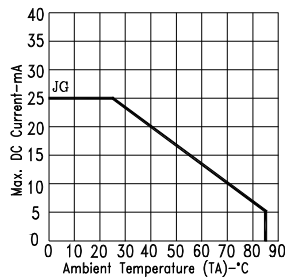

Fig5. MAX. ALLOWABLE DC CURRENT VS. AMBIENT TEMPERATURE.

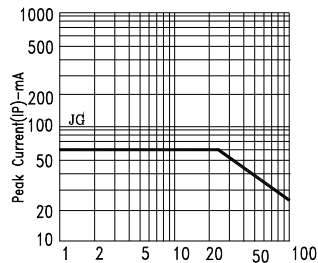

Fig6. MAX. PEAK CURRENT VS. DUTY CYCLE % (REFRESH RATE 1KHz)

NOTE : JG=AlInGaP Green

## LED DISPLAY LTS-4801JG

### 7. Reliability Test

Classification	Test Item	Test Condition	Reference Standard
<b>Endurance Test</b>	<b>Operation Life</b>	<b>RTOL</b> Ta=Under Room Temperature IF=As per data sheet maximum Rating * Test Time= 1000Hrs (-24Hrs, +72Hrs)	MIL-STD-750D:1026 (1995) MIL-STD-883E:1005 (1996) JIS C 7021: B-1 (1982)
	<b>High Temperature High Humidity Storage</b>	<b>THS</b> Ta= 65±5°C RH=90 ~ 95% Test Time=500Hrs (±2Hrs)	MIL-STD-202G:103B (2002) JIS C 7021: B-11 (1982)
	<b>High Temperature Storage</b>	<b>HTS</b> Ta= 105±5°C Test Time=1000Hrs (-24Hrs, +72Hrs)	MIL-STD-883E:1008 (1996) JIS C 7021: B-10 (1982)
	<b>Low Temperature Storage</b>	<b>LTS</b> Ta= -35±5°C Test Time=1000Hrs (-24Hrs, +72Hrs)	JIS C 7021: B-12 (1982)
<b>Environmental Test</b>	<b>Temperture Cycling</b>	<b>TC</b> 105°C ~ 25°C ~ -35°C ~ 25°C 30mins ~ 5mins ~ 30mins ~ 5mins 30 Cycles	MIL-STD-202G:107D (2002) MIL-STD-750D:1051 (1995) MIL-STD-883E:1010 (1996) JIS C 7021: A-4 (1982)
	<b>Thermal Shock</b>	<b>TS</b> 105 ±5°C ~ -35 ±5°C 30mins ~ 30mins 30 Cycles	MIL-STD-202G:107D (2002) MIL-STD-750D:1051 (1995) MIL-STD-883E:1011 (1996)
	<b>Solder Resistance</b>	<b>SR</b> T.Sol=260 ±5°C Dwell Time= 10 ±1 secs (For solder pin only)	MIL-STD-202G:210A (2002) MIL-STD-750D:2031 (1995) JIS C 7021: A-1 (1982)
	<b>Solderability</b>	<b>SA</b> T.Sol=245 ±5°C Dwell Time= 5 ±1 secs (For solder pin only)	MIL-STD-202G:208D (2002) MIL-STD-750D:2026 (1995) MIL-STD-883E:2003 (1996) JIS C 7021: A-2 (1982)

\* (Check point: 0th, 168th, 500th, 800th, 1000th Hrs)

Follow as : QS-00TP-RELBE-0001 Reliability Test Conditions



## 8. Soldering Profile

### 8.1 Auto Soldering

Solder Conditions: 1/16 inch below seating plane for 5 seconds at 260°C, or temperature of unit (during assembly) not over max. Temperature rating above.

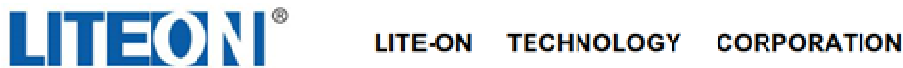

\*\* Flow(=Wave soldering ) condition with temperature for Pb free Soldering

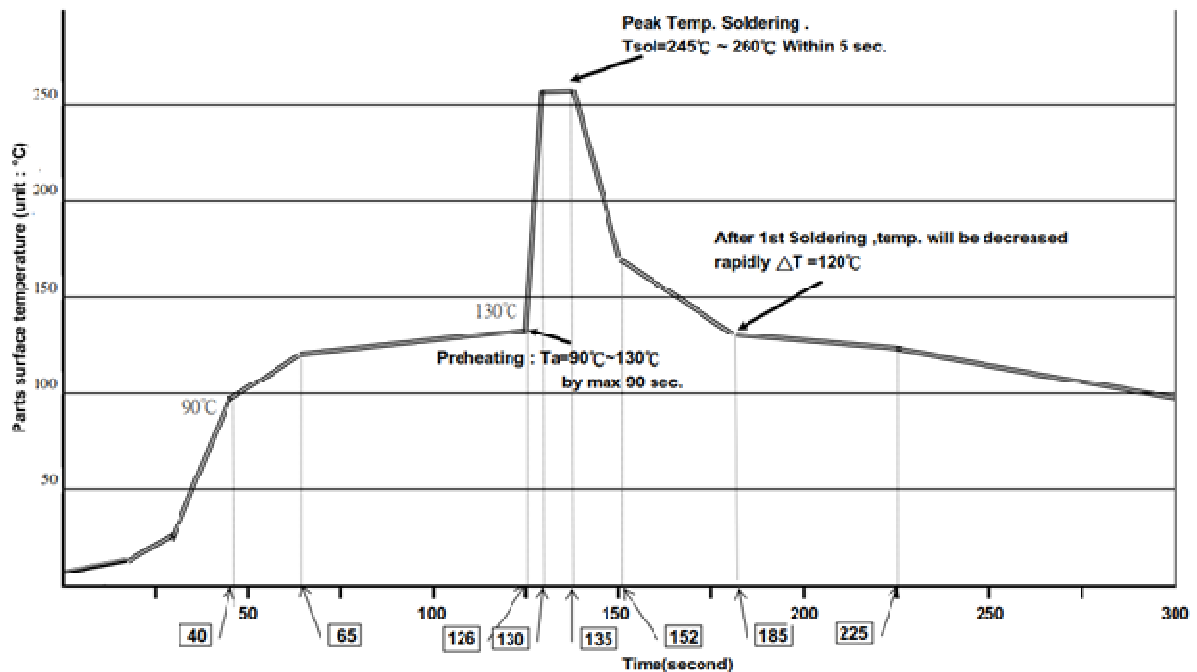

### 8.2 Manual Soldering

Solder Conditions: 1/16 inch below seating plane within 5 seconds at 350°C±30°C.

## LED DISPLAY LTS-4801JG

### 9. CAUTIONS

#### 9.1 Application

- The display described here are intended to be used for ordinary electronic equipment (such as office equipment, communication equipment and household applications). Consult Liteon's Sales in advance for information on applications in which exceptional reliability is required, particularly when the failure or malfunction of the display may directly jeopardize life or health (such as in aviation, transportation, traffic control equipment, medical and life support systems, and safety devices).
- When using this LED display, please make sure absolute maximum ratings and the instructions for using outlined in these specification sheets. LITEON will not be responsible for any damage resulting from use of the product which does not comply with the absolute maximum ratings and the instructions included in these specification sheets.
- Excess driving current and/or operating temperature higher than recommended conditions may result in severe light degradation or premature failure.
- The driving circuit should be designed to protect the LEDs inside the display against reverse voltages and transient voltage spikes when the circuit is powered up or shut down.
- Constant current driving is recommended to ensure consistent performance.
- Circuit design must cater to the whole range of forward voltage (VF) of the LEDs inside the display to ensure the intended drive current can always be achieved.
- The safe operating current should be chosen after considering the maximum ambient temperature of the operating environment.
- Reverse bias should be avoided, as it could cause metal migration, leading to an increase in leakage current or causing a short circuit.
- Avoid rapid changes in ambient temperatures, especially in high-humidity environments, because they cause condensation on the LED/LED display.
- Do not use unsuitable tool or assembly method to have abnormal force on display body cause damage.
- Printing/pattern film is using pressure sensitive glue to stick on LED display surface, not recommend to let LED display pattern film side close contact with front panel/cover, since the printing/pattern film may shift or moved from original position by external force.
- Recommend choose same BIN LED display while you assemble 2 or above 2 pcs LED display for one set application to avoid hue uneven problems.

## LED DISPLAY LTS-4801JG

### 9.2 Storage conditions

- LED Display standard storage condition.
  - Product in the original packaging material state is recommended storage conditions.
  - Temperature Condition: 5°C~30°C
  - Humidity Condition: Below 60%RH

If the storage conditions do not meet specification standards, the LED display pins may become oxidized requiring re-plating and re-sorting before use. Suggest customers consume display as soon as possible and avoid long-term storage of large inventories. If unsealed package over 6 months, it is recommended baking at 60°C for 48 hours, and assembly within a week.
- LED SMD Display standard storage condition
  - When the package is in factory original sealed bag.
  - Temperature Condition: 5°C~30°C
  - Humidity Condition: Below 60%RH
  - When the package is opened and not in factory original sealed bag.
  - Temperature Condition: 5°C~30°C
  - Humidity Condition: Below 60%RH
  - Storage time: Within 168Hr (MSL as level 3)

If the storage conditions do not meet specification standards, the LED display pins or soldering pads may become oxidized requiring re-plating and re-sorting before use. Suggest customers consume display as soon as possible and avoid long-term storage of large inventories.
- Recommend to baking the LEDs at 60°C for 24hrs before soldering process if the LED SMD Display were unpacked more than 168hrs.
- Recommend using sealed package within 12 months from date code.
- The Displays should not be exposed to an environment where high level of moisture or corrosive gases are present.
- LED display pins and soldering pads are plated with gold, tin, or other metals. Under long-term exposure to open air, the exposed pins and pads may become oxidized causing poor solderability. Therefore, opened but unused parts must be stored in sealed containers or controlled environment. Suggest to store unused SMD Display parts in the original moisture barrier bag and sealed.
- Moisture control for components already mounted on PCB
  - If the PCB will not undergo additional reflow soldering or high-temperature processes, then no special treatment is required for the mounted moisture-sensitive SMD components. If the PCB will undergo multiple reflow soldering or other high-temperature processes, including rework, then the SMD component's cumulative exposure time until the final high-temperature process must be controlled to within the specified time limit.

## LED DISPLAY LTS-4801JG

### 9.3 Cleaning

- Do not use unspecified chemical liquid to clean display they could harm the package.

### 9.4 ESD (Electrostatic Discharge)

Static Electricity or power surge will damage LED inside the display.

Suggestions to prevent ESD damage:

- Use of a conductive wrist band or anti-electrostatic glove when handling these LED displays.
- All devices, equipment, and machinery, working tables, storage racks, etc. must be properly grounded.
- Use ion blower to neutralize the static charge which might have built up on surface of the LED display plastic as a result of friction between LED display during storage and handling.

### 9.5 Terms and conditions for the usage of this document

- Keep same appearance and performance the contents of the product may be modified for productivity and reliability improvement without prior notice.
- The information included in this document reflects representative usage scenarios and is intended for technical reference only.
- When using the products referenced in this document, please make sure the product is being operated within the environmental and electrical limits specified in the datasheet. If customer usage exceeds the specified limits, LITEON will not be responsible for any subsequent issues.
- Excess driving current and/or operating temperature higher than recommended conditions may result in severe light degradation or premature failure.
- The information in this document applies to typical usage in consumer electronics applications. If customer's application has special reliability requirements or have life-threatening liabilities, such as automotive or medical usage, please consult with LITEON representative for further assistance.
- The contents and information of this document may not be reproduced or re-transmitted without permission by LITEON.
- When any special process such as potting is required for LED display assembly, please consult with LITEON representative before proceeding.
- Over-current-proof

Customer must apply resistors for protection, otherwise slight voltage shift will cause big current change (Burn out will happen).